

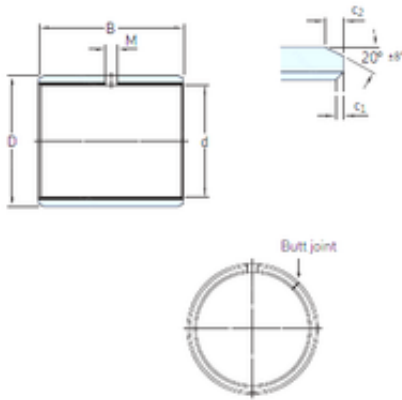

Lamar parts manufacturing company



50,8 mm x 55,563 mm x 38,1 mm SKF PCZ 3224 M plain bearings

Bearing No. PCZ 3224 M

Size	50.8x55.563x38.1 mm
Bore Diameter	50,8 mm
Outer Diameter	55,563 mm
Width	38,1 mm
d	50,8 mm
D	55,563 mm
B	38,1 mm
c1 min	0,2 mm
c2 min	1,2 mm
M	6 mm
Weight	0,105 Kg
Basic dynamic load rating (C)	228 kN
c ₁ min.	0.2 mm
c ₁ max.	1 mm
c ₂ min.	1.2 mm
c ₂ max.	2.4 mm
± 8	20 °
Shaft diameter range min.	50.452 mm
Shaft diameter range max.	50.498 mm
Housing bore range min.	55.563 mm
Housing bore range max.	55.593 mm
Basic dynamic load rating - radial direction C	228 kN
Basic static load rating - radial direction C ₀	475 kN

PCZ 3224 M Bearing 2D drawings and 3D CAD models



Lamar parts manufacturing company

Specific dynamic load factor K	120 N/mm ²
Specific static load factor K_0	250 N/mm ²
Factor depending on material and bearing type K_M	1900
Permissible sliding velocity v min.	0 m/s
Permissible sliding velocity v max.	2.5 m/s
Coefficient of friction μ min.	0.02
Coefficient of friction μ max.	0.2
Mass bushing	0.1 kg