

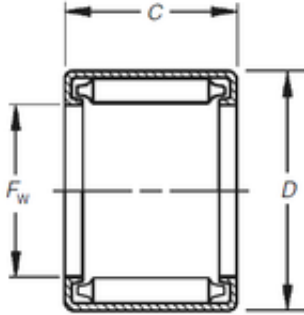

Lamar parts manufacturing company

Timken B-65 needle roller bearings



Bearing No. B-65

Size	9.525x14.288x7.92 mm
Bore Diameter	9,525 mm
Outer Diameter	14,288 mm
Width	7,92 mm
Fw	9,525 mm
D	14,288 mm
C	7,92 mm
Weight	0,004 Kg
Basic dynamic load rating (C)	4,54 kN
Basic static load rating (C0)	5,52 kN
(Grease) Lubrication Speed	4600 r/min

B-65 Bearing 2D drawings and 3D CAD models